

Fe



material: 1.0215 1103 'PRESTABO'

cev

12x1,2	
15x1,2	
18x1,2	
22x1,5	
28x1,5	
35x1,5	
42x1,5	
54x1,5	
64x2,0	
76x2,0	
89x2,0	
108x2,0	

Fe-PP



1104 'PRESTABO'

PP izolirana cev

15x1,2	
18x1,2	
22x1,5	
28x1,5	
35x1,5	
42x1,5	
54x1,5	

Fe



material: 1.0215 1106 'PRESTABO'

cev za protipožarne sisteme

22x1,5	
28x1,5	
35x1,5	
42x1,5	
54x1,5	
64x2,0	
76x2,0	
89x2,0	
108x2,0	

Fe



1109.3 'PRESTABO'

izogibni lok

12	
15	
18	
22	

Fe



1116 'PRESTABO'

lok dvojni 90°

12	
15	
18	
22	
28	
35	
42	
54	

Fe



1116.1 'PRESTABO'

lok enojni 90°

12	
15	
18	
22	
28	
35	
42	
54	

Fe



1116XL 'PRESTABO'

XL lok dvojni 90°

64	
76	
89	
108	

Fe



1116.1XL 'PRESTABO'

XL lok enojni 90°

64	
76	
89	
108	

Fe



1126 'PRESTABO'

lok dvojni 45°

12	
15	
18	
22	
28	
35	
42	
54	

Fe



1126.1 'PRESTABO'

lok enojni 45°

12	
15	
18	
22	
28	
35	
42	
54	

Fe



1126XL 'PRESTABO'

XL lok dvojni 45°

64	
76	
89	
108	

Fe



1126.1XL 'PRESTABO'

XL lok enojni 45°

64	
76	
89	
108	

Fe



1111
'PRESTABO'

**prehodni kos
zunanji navoj**

12-3/8"	
12-1/2"	
15-3/8"	
15-1/2"	
15-3/4"	
18-1/2"	
18-3/4"	
22-1/2"	
22-3/4"	
28-3/4"	
28-1"	
28-1 1/4"	
35-1 1/4"	
35-1 1/2"	
42-1 1/2"	
54-2"	

Fe



1111XL
'PRESTABO'

**XL prehodni kos
zunanji navoj**

64-2"	
64-2 1/2"	
76-2 1/2"	
89-3"	
108-4"	

Fe



1112
'PRESTABO'

**prehodni kos
notranji navoj**

12-3/8"	
12-1/2"	
15-3/8"	
15-1/2"	
15-3/4"	
18-1/2"	
18-3/4"	
22-1/2"	
22-3/4"	
22-1"	
28-3/4"	
28-1"	
35-3/4"	
35-1 1/4"	
42-1 1/2"	
54-2"	

Fe



1112XL
'PRESTABO'

**XL prehodni kos
notranji navoj**

64-2"	
64-2 1/2"	
76-2 1/2"	
89-3"	
108-4"	

Fe



1115
'PRESTABO'

spojka

12	
15	
18	
22	
28	
35	
42	
54	

Fe



1115.5
'PRESTABO'

drsna spojka

12	
15	
18	
22	
28	
35	
42	
54	

Fe



1115.1
'PRESTABO'

reducirka "A"

15a-12	
18a-12	
18a-15	
22a-12	
22a-15	
22a-18	
28a-15	
28a-18	
28a-22	
35a-15	
35a-22	
35a-28	
42a-22	
42a-28	
42a-35	
54a-22	
54a-28	
54a-35	
54a-42	

Fe



1115.1XL
'PRESTABO'

XL reducirka "A"

64a-54	
76a-54	
76a-64	
89a-54	
89a-64	
89a-76	
108a-54	
108a-64	
108a-76	
108a-89	

Fe



1115XL
'PRESTABO'

XL spojka

64	
76	
89	
108	

Fe



1115.5XL
'PRESTABO'

XL drsna spojka

64	
76	
89	
108	

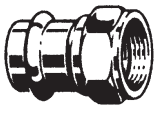
Fe  1163
'PRESTABO'

privijalo z ravnim tesnenjem

15-3/4"	
15-1"	
18-1"	
22-1"	
22-1 1/4"	
22-1 1/2"	
28-1 1/4"	
28-1 1/2"	
35-1 1/2"	
35-2"	
42-1 3/4"	
42-2"	
54-2 3/8"	
54-2 1/2"	

Fe  1114
'PRESTABO'

lok - zunanji navoj

12-3/8"	
12-1/2"	
15-3/8"	
15-1/2"	
18-1/2"	
22-3/4"	
28-1"	
35-1 1/4"	
42-1 1/2"	
54-2"	

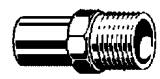
Fe  1111.1
'PRESTABO'

vstavni prehodni kos zunanji navoj

12-3/8"	
12-1/2"	
15-1/2"	
18-1/2"	
22-3/4"	
28-1"	

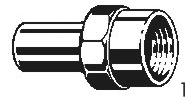
Fe  1112.1
'PRESTABO'

vstavni prehodni kos notranji navoj

15-1/2"	
18-1/2"	
18-3/4"	
22-1/2"	
22-3/4"	

Fe  1159
'PRESTABO'

prirobnica

(DN32) 35	
(DN40) 42	
(DN50) 54	

Fe  1160
'PRESTABO'

privijalo dvojno ravno tesnenje

12	
15	
18	
22	
28	
35	
42	
54	

Fe  1165
'PRESTABO'

privijalo z.n.n. ravno tesnenje

15-1/2"	
22-3/4"	
22-1"	
28-1"	
35-1 1/4"	
42-1 1/2"	
54-2"	

Fe  1162
'PRESTABO'

privijalo n.n.n. ravno tesnenje

15-1/2"	
18-1/2"	
22-3/4"	
22-1"	
28-1"	
35-1 1/4"	
42-1 1/2"	
54-2"	

Fe  1159XL
'PRESTABO'

XL prirobnica

(DN65)64	
(DN65)76	
(DN80)89	
(DN100)108	

AFM 34  PN16
2259.9
'PRESS'

tesnilo

DN 25	
DN 32	
DN 40	
DN 50	
DN 65	
DN 80	
DN 100	

Fe  1156
'PRESTABO'

kapa

12	
15	
18	
22	
28	
35	
42	
54	

Fe  1157.1
'PRESTABO'

vstavna kapa

12	
15	
18	
22	
28	
35	
42	
54	

Fe  1157.1XL
'PRESTABO'

XL vstavna kapa

64	
76	
89	
108	

Fe  2259.7
'PRESTABO'

prirobnični vijak - set

DN25/M12x65	
DN32-50/M16x70	
DN65-100/M16x70	