

Fe

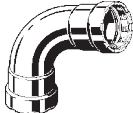

4216
'MEGAPRESS'

lok dvojni 90°

3/8	
1/2	
3/4	
1	
1 1/4	
1 1/2	
2	

Fe



4216.1
'MEGAPRESS'

lok enojni 90°

3/8	
1/2	
3/4	
1	
1 1/4	
1 1/2	
2	

Fe

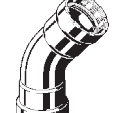

4226
'MEGAPRESS'

lok dvojni 45°

3/8	
1/2	
3/4	
1	
1 1/4	
1 1/2	
2	

Fe



4226.1
'MEGAPRESS'

lok enojni 45°

3/8	
1/2	
3/4	
1	
1 1/4	
1 1/2	
2	

Fe



4216XL
'MEGAPRESS'

XL lok dvojni 90°

2 1/2	
3	
4	

Fe



4216.1XL
'MEGAPRESS'

XL lok enojni 90°

2 1/2	
3	
4	

Fe



4226XL
'MEGAPRESS'

XL lok dvojni 45°

2 1/2	
3	
4	

Fe



4226.1XL
'MEGAPRESS'

XL lok enojni 45°

2 1/2	
3	
4	

Fe

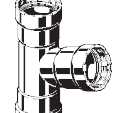

4218
'MEGAPRESS'

T - kos

3/8-3/8-3/8
1/2-1/2-1/2
3/4-1/2-3/4
3/4-3/4-3/4
1-1/2-1
1-3/4-1
1-1-1
1 1/4-1/2-1 1/4
1 1/4-3/4-1 1/4
1 1/4-1-1 1/4
1 1/4-1 1/4-1 1/4
1 1/2-1/2-1 1/2
1 1/2-3/4-1 1/2
1 1/2-1-1 1/2
1 1/2-1 1/4-1 1/2
1 1/2-1 1/2-1 1/2
2-1/2-2
2-3/4-2
2-1-2
2-1 1/4-2
2-1 1/2-2
2-2-2

Fe

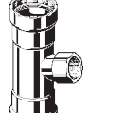

4217.2
'MEGAPRESS'

T - kos n.n.

1/2-1/2"-1/2
3/4-1/2"-3/4
1-1/2"-1
1-3/4"-1
1 1/4-1/2"-1 1/4
1 1/4-3/4"-1 1/4
1 1/4-1"-1 1/4
1 1/2-1/2"-1 1/2
1 1/2-3/4"-1 1/2
1 1/2-1"-1 1/2
2-1/2"-2
2-3/4"-2
2-1"-2

Fe

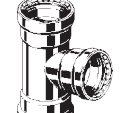

4218XL
'MEGAPRESS'

XL T - kos

2 1/2-1-2 1/2
2 1/2-1 1/4-2 1/2
2 1/2-1 1/2-2 1/2
2 1/2-2-2 1/2
2 1/2-2 1/2-2 1/2
3-1-3
3-1 1/4-3
3-1 1/2-3
3-2-3
3-2 1/2-3
3-3-3
4-1-4
4-1 1/4-4
4-1 1/2-4
4-2-4
4-2 1/2-4
4-3-4
4-4-4

Fe

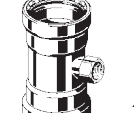

4217.2XL
'MEGAPRESS'

XL T - kos n.n.

2 1/2-3/4"-2 1/2
3-3/4"-3
4-3/4"-4

Fe



4212.2
'MEGAPRESS'

zatisni priključek

1 1/2-3/4"
2-3/4"
2 1/2-3/4"
3-3/4"
4-3/4"
5-3/4"
6-3/4"

Rg



3241.1
'MEGAPRESS'

reducirka

3/4"-1/2"

Fe  4215
'MEGAPRESS'

spojka

3/8	
1/2	
3/4	
1	
1 1/4	
1 1/2	
2	

Fe  4215.5
'MEGAPRESS'

drсна spojka

3/8	
1/2	
3/4	
1	
1 1/4	
1 1/2	
2	

Fe  4215.2
'MEGAPRESS'

reducirna spojka

3/4-1/2	
1-1/2	

Fe  4215.7
'MEGAPRESS'

reducirna spojka

1 1/2-1 1/4 (ø44,5)	
2-2 (ø57)	

Fe  4215XL
'MEGAPRESS'

XL spojka

2 1/2	
3	
4	

Fe  4215.5XL
'MEGAPRESS'

XL drсна spojka

2 1/2	
3	
4	

Fe  4215.4
'MEGAPRESS'

drсна spojka A

3/8	
1/2	
3/4	
1	

Fe  4212.5
'MEGAPRESS'

vstavni kos

1-1/2"	
1-3/4"	
1 1/4-1/2"	
1 1/4-3/4"	
1 1/4-1"	

Fe  4211
'MEGAPRESS'

prehodni kos z.n.

3/8-3/8"	
3/8-1/2"	
1/2-1/2"	
3/4-3/4"	
1-1"	
1 1/4-1 1/4"	
1 1/2-1 1/2"	
2-2"	

Fe  4211.3
'MEGAPRESS'

prehodni kos z.n.

1 1/4(ø44,5)-1"	
2(ø57)-1 1/4"	

Fe  4211XL
'MEGAPRESS'

XL prehodni kos z.n.

2 1/2-2 1/2"	
3-3"	
4-4"	

Fe  4265
'MEGAPRESS'

privijalo z.n.n.

1/2-1/2"	
3/4-3/4"	
1-1"	
1 1/4-1 1/4"	
1 1/2-1 1/2"	
2-2"	

Fe  4212
'MEGAPRESS'

prehodni kos n.n.

3/8-3/8"	
3/8-1/2"	
1/2-1/2"	
3/4-3/4"	
1-1"	
1 1/4-1 1/4"	
1 1/2-1 1/2"	
2-2"	

Fe  4212XL
'MEGAPRESS'

XL prehodni kos n.n.

2 1/2-2 1/2"	
3-3"	
4-4"	

Fe  4263
'MEGAPRESS'

privijalo rav. t.

1/2-3/4"	
3/4-1"	
1-1 1/4"	
1-1 1/2"	
1 1/4-1 1/2"	
1 1/4-2"	
1 1/2-1 1/2"	
2-2"	

Fe  4213.1
'MEGAPRESS'

prehodni kos ož. cev

1-ø33,7	
1 1/4-ø42,4	
1 1/2-ø48,3	
2-ø60,3	

Cevi po DIN EN 10255, DIN EN 10220/DIN EN 10216-1, DIN EN 10220/DIN EN 10217-1

Dimenzija D	Nazivni premer DN	Zunanji ø	Zunanji ø s premazom		Debelina stene	
			min.	max.	min.	max.
3/8	10	17,2	16,7	17,7	1,4	4,5
1/2	15	21,3	20,8	21,8	1,4	5,0
3/4	20	26,9	26,4	27,4	1,4	8,0
1	25	33,7	33,2	34,2	1,4	8,8
1¼	32	42,4	41,9	42,9	1,4	10,0
-	32	44,5	44,0	45,0	1,4	12,5
1½	40	48,3	47,8	48,8	1,4	12,5
-	50	57,0	56,4	57,6	1,4	14,2
2	50	60,3	59,6	60,9	1,4	16,0
2½	65	76,1	75,2	76,9	1,4	20,0
3	80	88,9	87,9	89,8	1,4	25,0
4	100	114,3	113,0	115,4	1,4	32,0