

Cu  2416 'PRESS'

**lok dvojni 90°**

12	
15	
18	
22	
28	
35	
42	
54	

Cu  2416.1 'PRESS'

**lok enojni 90°**

12	
15	
18	
22	
28	
35	
42	
54	

Cu  2416XL 'PRESS'

**XL lok dvojni 90°**

64	
76	
89	
108	

Cu  2416.1XL 'PRESS'

**XL lok enojni 90°**

64	
76	
89	
108	

Cu  2426 'PRESS'

**lok dvojni 45°**

12	
15	
18	
22	
28	
35	
42	
54	

Cu  2426.1 'PRESS'

**lok enojni 45°**

12	
15	
18	
22	
28	
35	
42	
54	

Cu  2426XL 'PRESS'

**XL lok dvojni 45°**

64	
76	
89	
108	

Cu  2426.1XL 'PRESS'

**XL lok enojni 45°**

64	
76	
89	
108	

Rg  2214 'PRESS'

**lok - zunanji navoj**

12- <sup>3</sup> / <sub>8</sub> "	
12- <sup>1</sup> / <sub>2</sub> "	
15- <sup>3</sup> / <sub>8</sub> "	
15- <sup>1</sup> / <sub>2</sub> "	
15- <sup>3</sup> / <sub>4</sub> "	
18- <sup>1</sup> / <sub>2</sub> "	
18- <sup>3</sup> / <sub>4</sub> "	
22- <sup>3</sup> / <sub>4</sub> "	
28-1"	
35-1 <sup>1</sup> / <sub>4</sub> "	
42-1 <sup>1</sup> / <sub>2</sub> "	
54-2"	

Rg  2214.2 'PRESS'

**koleno - notranji navoj**

12- <sup>3</sup> / <sub>8</sub> "	
12- <sup>1</sup> / <sub>2</sub> "	
15- <sup>3</sup> / <sub>8</sub> "	
15- <sup>1</sup> / <sub>2</sub> "	
15- <sup>3</sup> / <sub>4</sub> "	
18- <sup>1</sup> / <sub>2</sub> "	
18- <sup>3</sup> / <sub>4</sub> "	
22- <sup>1</sup> / <sub>2</sub> "	
22- <sup>3</sup> / <sub>4</sub> "	
22-1"	
28- <sup>1</sup> / <sub>2</sub> "	
28- <sup>3</sup> / <sub>4</sub> "	
28-1"	
35-1 <sup>1</sup> / <sub>4</sub> "	
42-1 <sup>1</sup> / <sub>2</sub> "	
54-2"	

Cu  2427 'PRESS'

**izogibni lok "A"**

12	
15	
18	
22	

Cu  2428 'PRESS'

**izogibni lok "B"**

15	
18	
22	

Cu  2456 'PRESS'

**kapa**

12	
15	
18	
22	
28	
35	
42	
54	

Cu  2456XL 'PRESS'

**XL kapa**

64	
76	
89	
108	

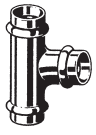
Cu  2418 'PRESS'

**T - kos**

12	
15	
18	
22	
28	
35	
42	
54	

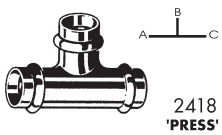
Cu  2418 'PRESS'

**reducirni T - kos**

12-15-12	
15-12-12	
15-12-15	
15-15-12	
15-18-15	
15-22-15	
18-12-15	
18-12-18	
18-15-15	
18-15-18	
18-18-15	
18-22-18	
22-12-22	
22-15-15	
22-15-18	
22-15-22	
22-18-15	
22-18-18	
22-18-22	
22-22-15	
22-22-18	
22-28-22	
28-15-22	
28-15-28	
28-18-22	
28-18-28	
28-22-22	
28-22-28	
28-28-22	
35-15-35	
35-18-35	
35-22-28	
35-22-35	
35-28-28	
35-28-35	
35-35-22	
35-35-28	
42-22-42	
42-28-42	
42-35-42	
54-22-54	
54-28-54	
54-35-54	
54-42-54	

Rg  2217.1 'PRESS'

**T-kos zunanji navoj**

18-3/4"-18	
22-3/4"-22	
28-3/4"-28	
35-3/4"-35	
42-3/4"-42	
54-3/4"-54	
54-1"-54	
54-1 1/4"-54	

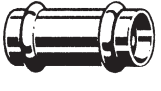
Cu  2415 'PRESS'

**spojka**

12	
15	
18	
22	
28	
35	
42	
54	

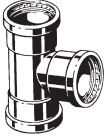
Cu  2418XL 'PRESS'

**XL reducirni T - kos**

64	
76	
89	
108	
64-35-64	
64-42-64	
64-54-64	
76-54-76	
89-54-89	
89-76-89	
108-54-108	
108-76-108	
108-89-108	

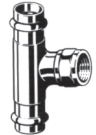
Rg  2217.2 'PRESS'

**T-kos notranji navoj**

12-1/2"-12	
15-3/8"-15	
15-1/2"-15	
18-1/2"-18	
22-1/2"-22	
22-3/4"-22	
28-1/2"-28	
28-3/4"-28	
35-1/2"-35	
35-1"-35	
42-1/2"-42	
42-1"-42	
54-1/2"-54	
54-1"-54	

Cu  2415XL 'PRESS'

**XL spojka**

64	
76	
89	
108	

Cu  2415.3 'PRESS'

**drsna spojka**

12	
15	
18	
22	
28	
35	
42	
54	

Cu-Rg  2417.2XL 'PRESS'

**XL T - kos n.n.**

64-3/4"-64	
64-1"-64	
76-3/4"-76	
76-2"-76	
89-3/4"-89	
89-2"-89	
108-3/4"-108	
108-2"-108	

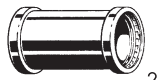
Cu  2415.5XL 'PRESS'

**XL drsna spojka**

64	
76	
89	
108	

Cu  2415.2 'PRESS'

**reducirka**

15-12	
18-15	
22-15	
22-18	
28-22	
35-28	
42-35	
54-42	

Cu  2415.1 'PRESS'

**reducirka "A"**

15a-12	
18a-12	
18a-15	
22a-15	
22a-18	
28a-15	
28a-18	
28a-22	
35a-22	
35a-28	
42a-22	
42a-28	
42a-35	
54a-28	
54a-35	
54a-42	

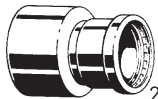
Cu  2415.1XL 'PRESS'

**XL reducirka "A"**

64a-42	
64a-54	
76a-54	
76a-64	
89a-54	
89a-76	
108a-54	
108a-76	
108a-89	

Rg  2211 'PRESS'

**prehodni kos zunanji navoj**

12-3/8"	
12-1/2"	
15-3/8"	
15-1/2"	
15-3/4"	
18-1/2"	
18-3/4"	
22-1/2"	
22-3/4"	
22-1"	
28-3/4"	
28-1"	
28-1 1/4"	
35-1"	
35-1 1/4"	
35-1 1/2"	
42-1 1/4"	
42-1 1/2"	
54-1 1/2"	
54-2"	

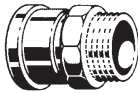
Cu  2411XL 'PRESS'

**XL prehodni kos zunanji navoj**

64-2 1/2"	
76-2 1/2"	
89-3"	
108-4"	

Rg  2211XL 'PRESS'

**XL prehodni kos zunanji navoj**

76-2 1/2"	
89-3"	
108-4"	

Rg  2212 'PRESS'

**prehodni kos notranji navoj**

12-3/8"	
12-1/2"	
15-3/8"	
15-1/2"	
15-3/4"	
18-1/2"	
18-3/4"	
22-1/2"	
22-3/4"	
22-1"	
28-1/2"	
28-3/4"	
28-1"	
28-1 1/4"	
35-3/4"	
35-1"	
35-1 1/4"	
42-1 1/4"	
42-1 1/2"	
54-1 1/2"	
54-2"	

Cu  2412XL 'PRESS'

**XL prehodni kos notranji navoj**

64-2 1/2"	

Rg-Rf  2251 'PRESS'

**kompensator**

15	
18	
22	
28	
35	
42	
54	

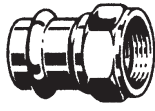
Rg  2263 'PRESS'

**privijalo z ravnim tesnenjem**

12-3/8"	
12-1/2"	
12-3/4"	
15-3/8"	
15-1/2"	
15-3/4"	
15-1"	
15-1 1/4"	
18-3/4"	
18-1"	
22-3/4"	
22-1"	
22-1 1/4"	
22-1 1/2"	
28-1"	
28-1 1/4"	
28-1 1/2"	
35-1 1/2"	
35-2"	
42-1 3/4"	
42-2"	
54-2 1/4"	
54-2 3/8"	
54-2 1/2"	
54-2 3/4"	

Rg  2263XL 'PRESS'

**XL privijalo z ravnim tesnenjem**

76-3"	
89-3 1/2"	

Rg  2265 'PRESS'

**privijalo z.n.n. ravno tesnenje**

12-3/8"	
12-1/2"	
15-1/2"	
15-3/4"	
18-1/2"	
18-3/4"	
22-1/2"	
22-3/4"	
22-1"	
28-3/4"	
28-1"	
35-1 1/4"	
42-1 1/2"	
54-2"	

Rg  2262 'PRESS'

**privijalo n.n.n. ravno tesnenje**

12-1/2"	
15-1/2"	
15-3/4"	
18-1/2"	
18-3/4"	
22-3/4"	
22-1"	
28-3/4"	
28-1"	
35-1 1/4"	
42-1 1/2"	
54-2"	

Rg  2260 'PRESS'

**privijalo dvojno ravno tesnenje**

12	
15	
18	
22	
28	
35	
42	
54	

Rg  2211.1 'PRESS'

**vstavni kos zunanji navoj**

12-1/2"	
15-1/2"	
18-1/2"	
18-3/4"	
22-1/2"	
22-3/4"	
28-1"	
35-1 1/4"	
42-1 1/2"	

Rg  2215 'SANPRESS'

**spojka**

15	
18	
22	
28	
35	
42	
54	

Rg  2225.5 'PRESS'

**kotni prehodni kos**

12-1/2"	
15-1/2"	
18-1/2"	
18-3/4"	
22-1/2"	
22-3/4"	

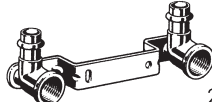
Rg  2222 'PRESS'

**montažna plošča**

15-1/2"	

Rg  2212.1 'PRESS'

**vstavni kos notranji navoj**

12-1/2"	
15-1/2"	
18-1/2"	
18-3/4"	
22-1/2"	
22-3/4"	
28-3/4"	
28-1"	
35-1"	
35-1 1/4"	
42-1 1/2"	
54-2"	

Rg  2215.5 'PRESS'

**drsna spojka**

15	
18	
22	
28	
35	
42	
54	

EPDM  2289 'PRESS'

**tesnilo**

12	
15	
18	
22	
28	
35	
42	
54	
64	
76	
89	
108	

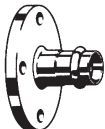
Rg  PN16 2259.5 'PRESS'

**prirobnica**

(DN25)	28
(DN32)	35
(DN40)	42
(DN50)	54
(DN65)	76
(DN80)	89
(DN100)	108

Cu  PN16 2459.5XL 'PRESS'

**XL prirobnica**

(DN65)	64
(DN65)	76
(DN80)	89
(DN100)	108

AFM 34  PN16 2259.9 'PRESS'

**tesnilo**

DN 25	
DN 32	
DN 40	
DN 50	
DN 65	
DN 80	
DN 100	

RF  PN16 2259.7 'PRESS'

**prirobnični vijak - set**

DN25/M12x65	
DN32-50/M16x70	
DN65-100/M16x70	